



CREATING  
**VALUE**

24V

**JOYGLOBAL**



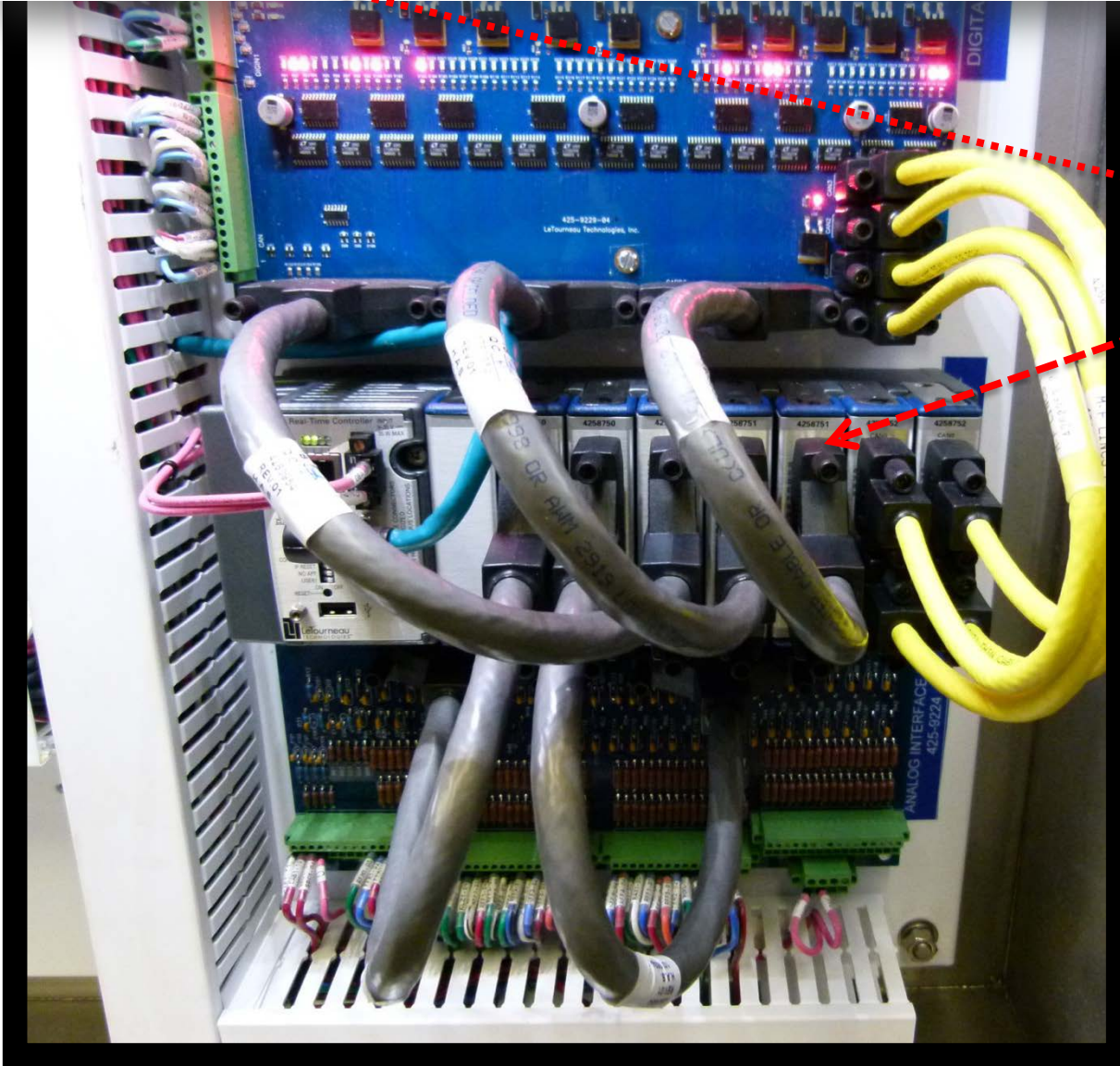
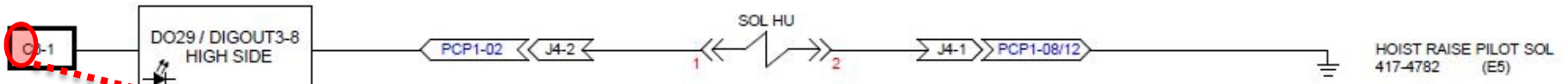

VCU Module 6

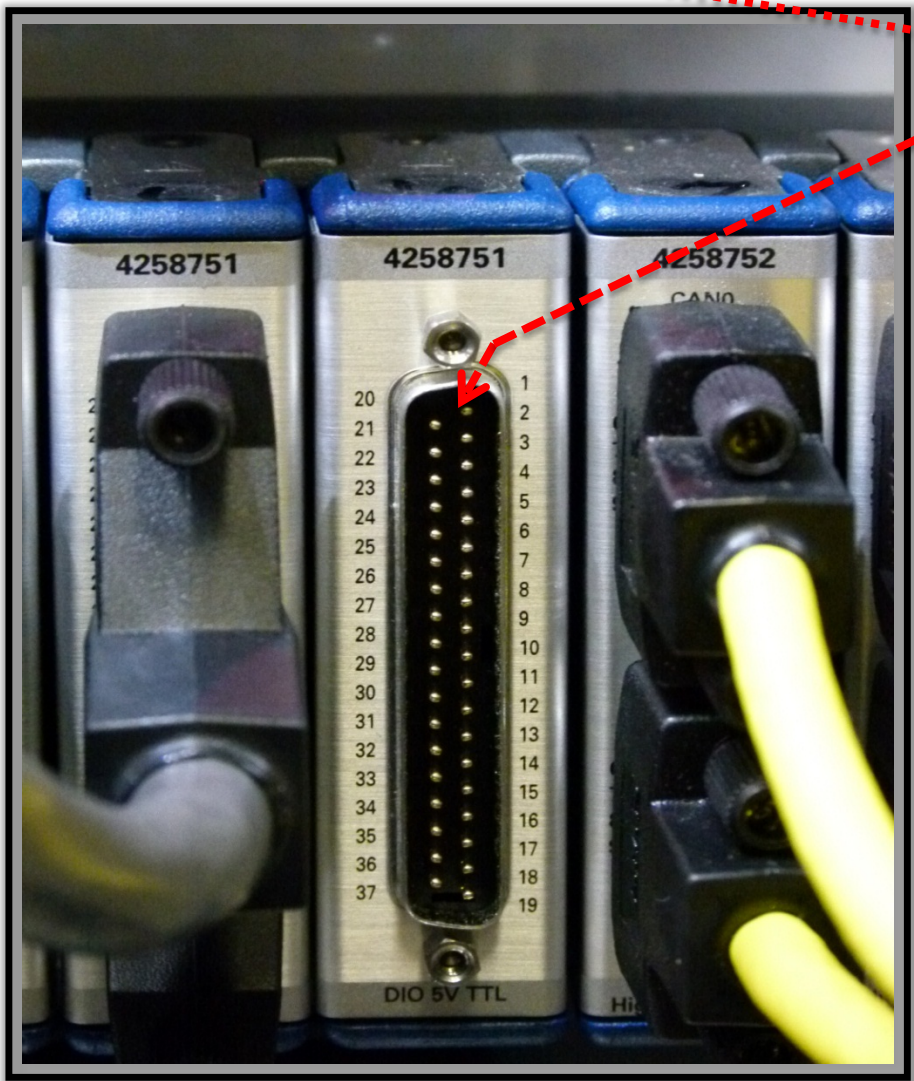
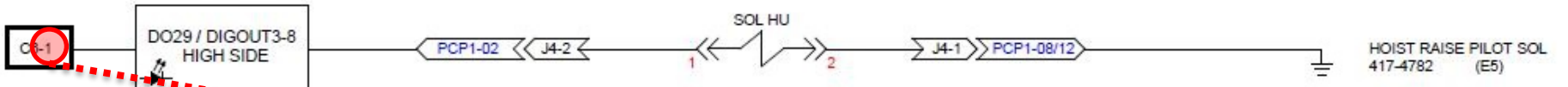

Pin 1

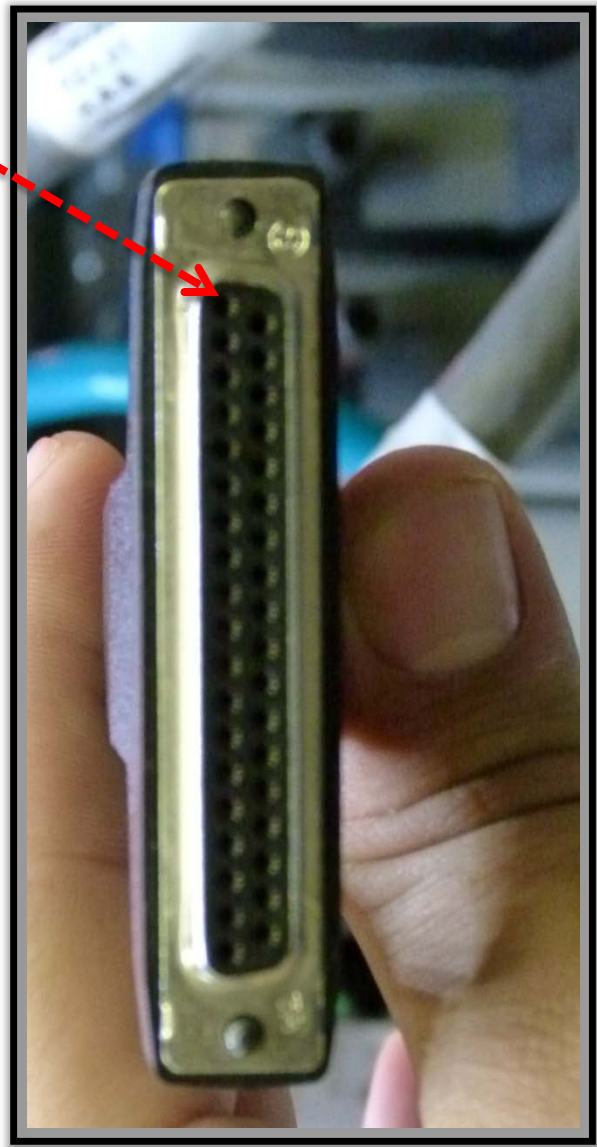

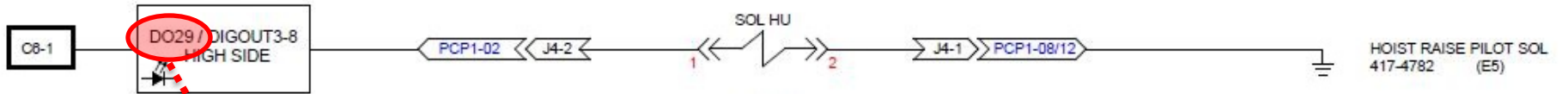

DO29 LED

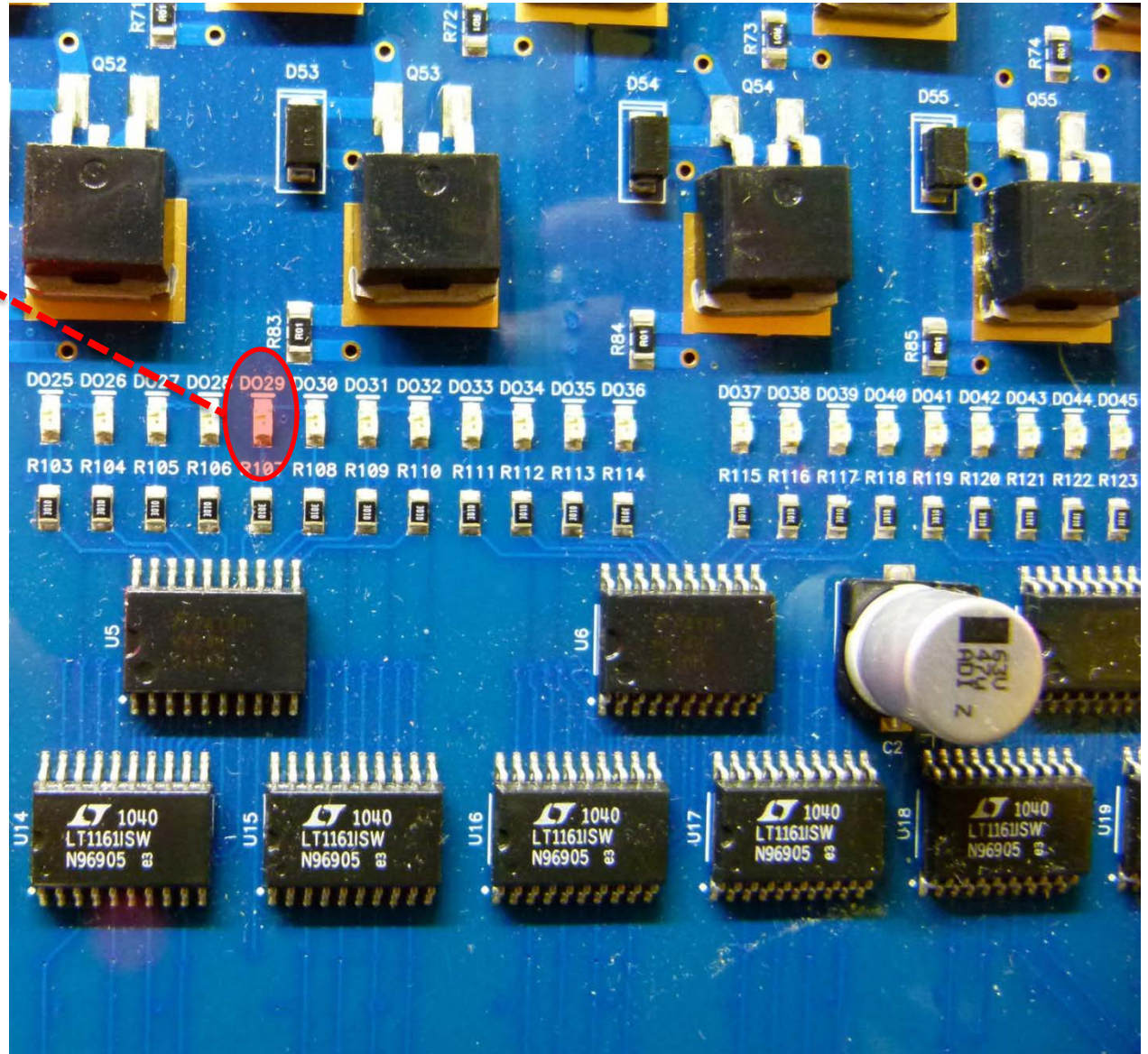

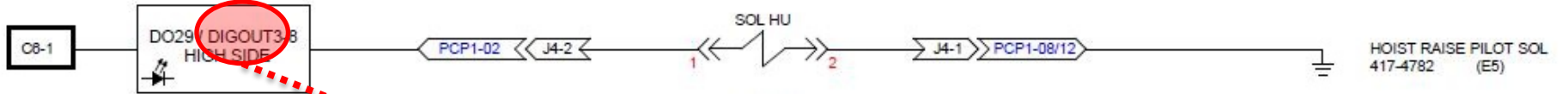

DIGOUT3

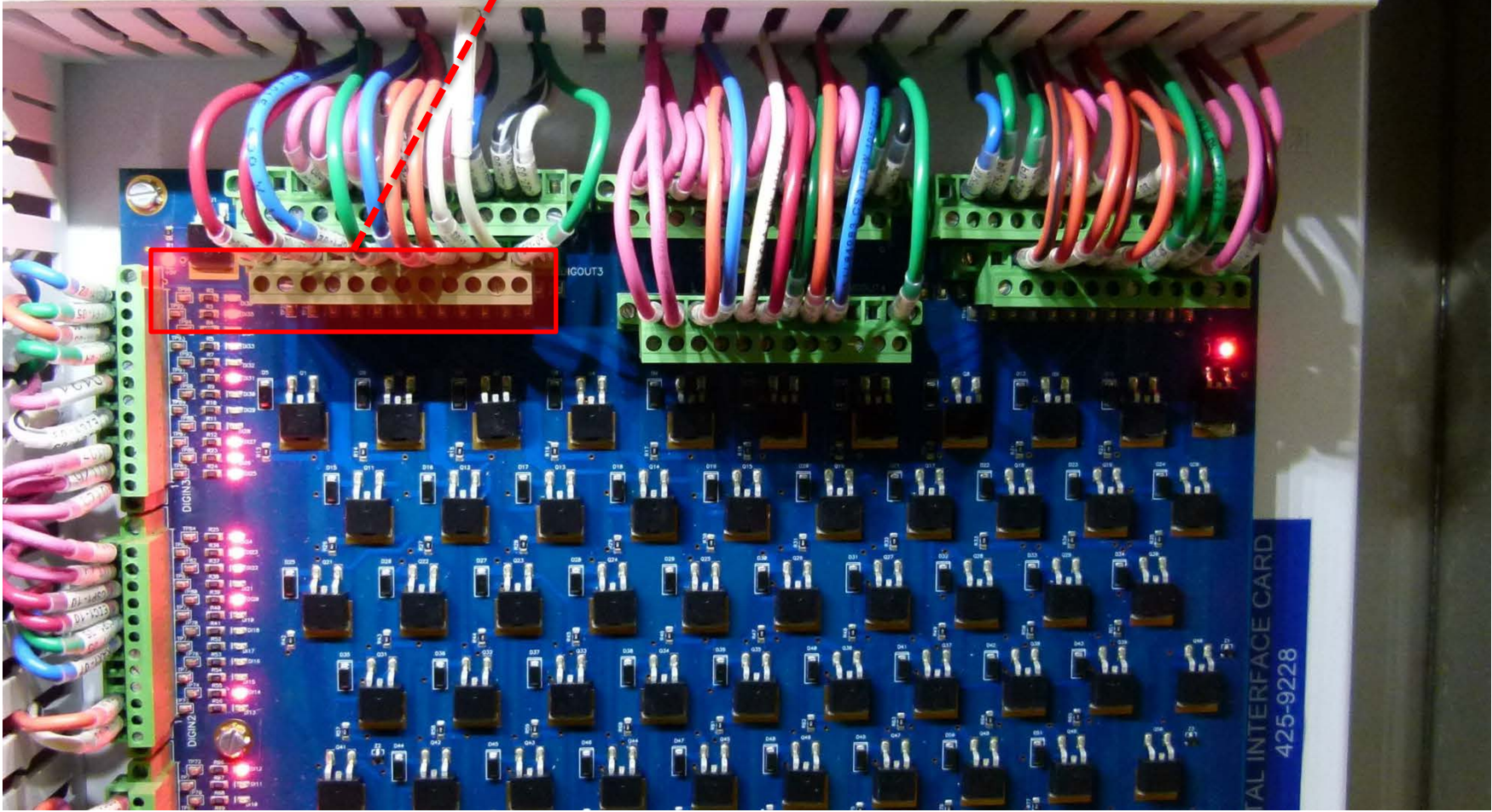



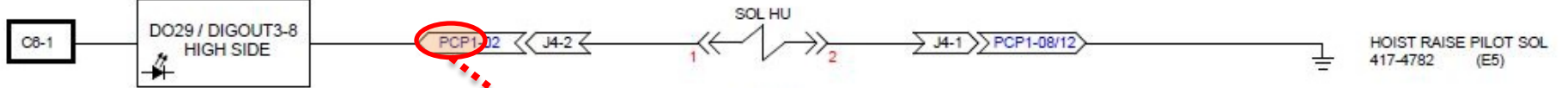

PCP1 12 pin cable at the back of the LVCC

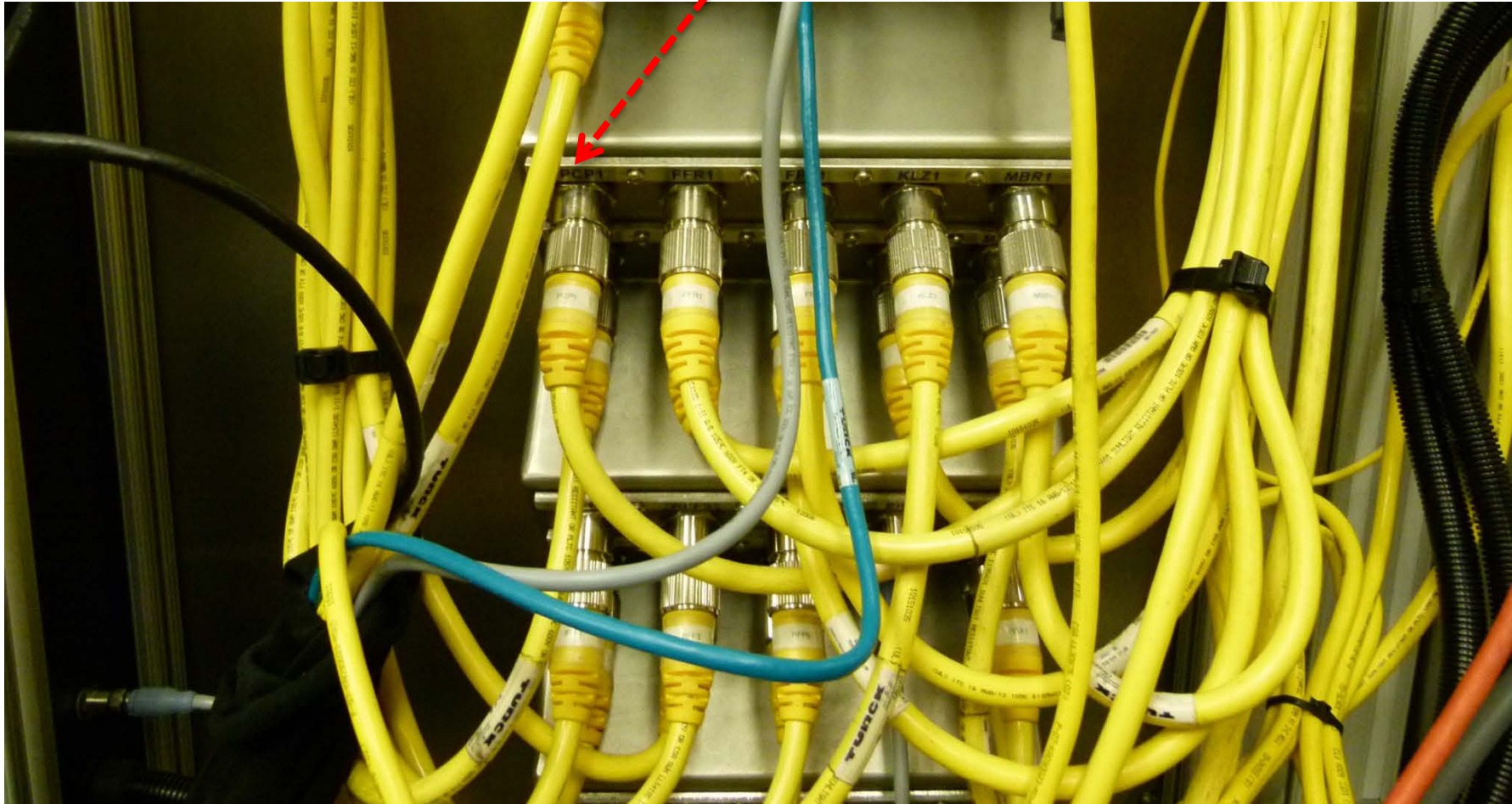

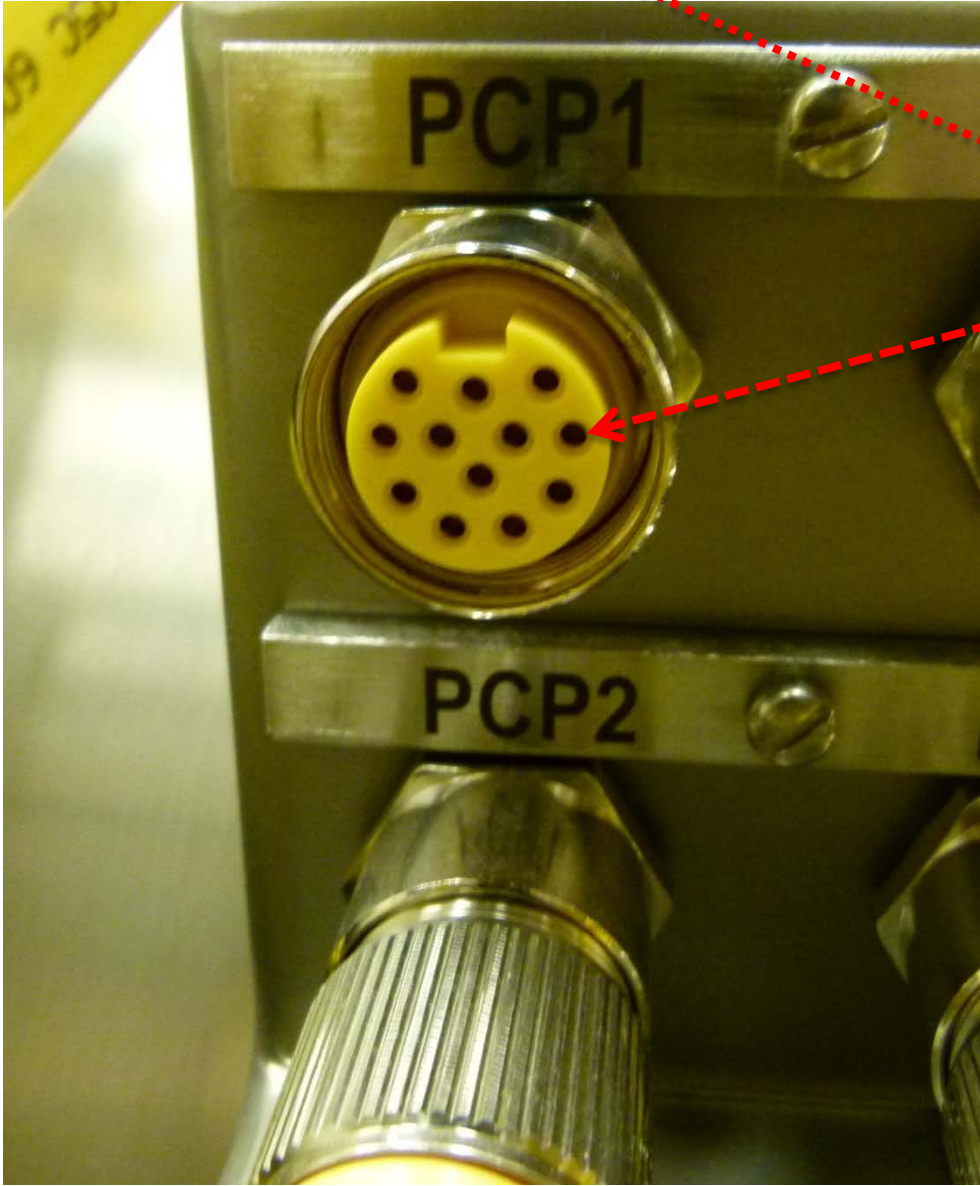
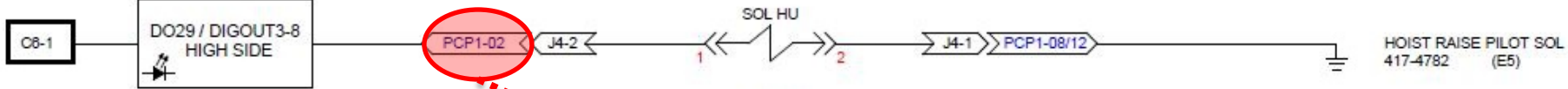

PCP1-02

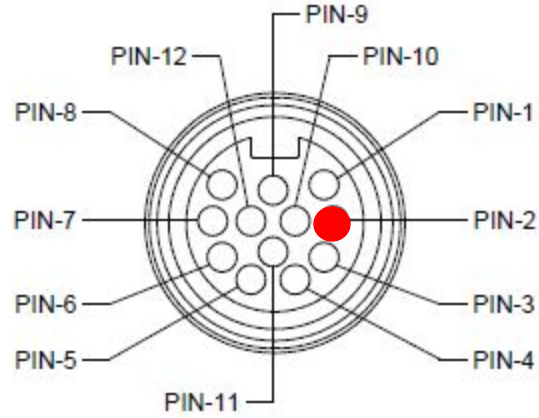

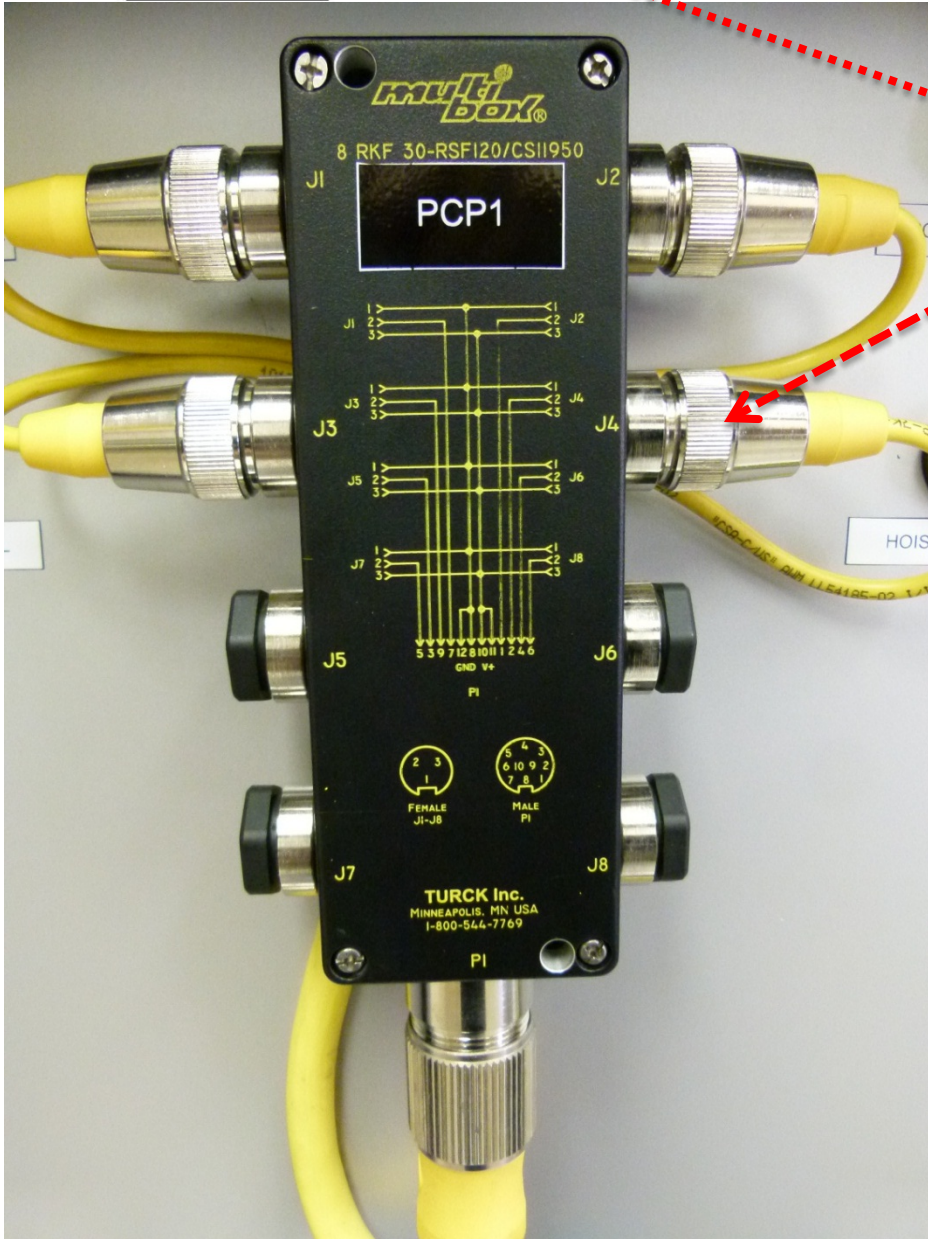
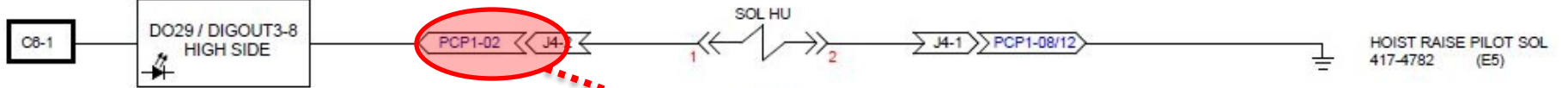

Break out Box PCP1  
Connector J4

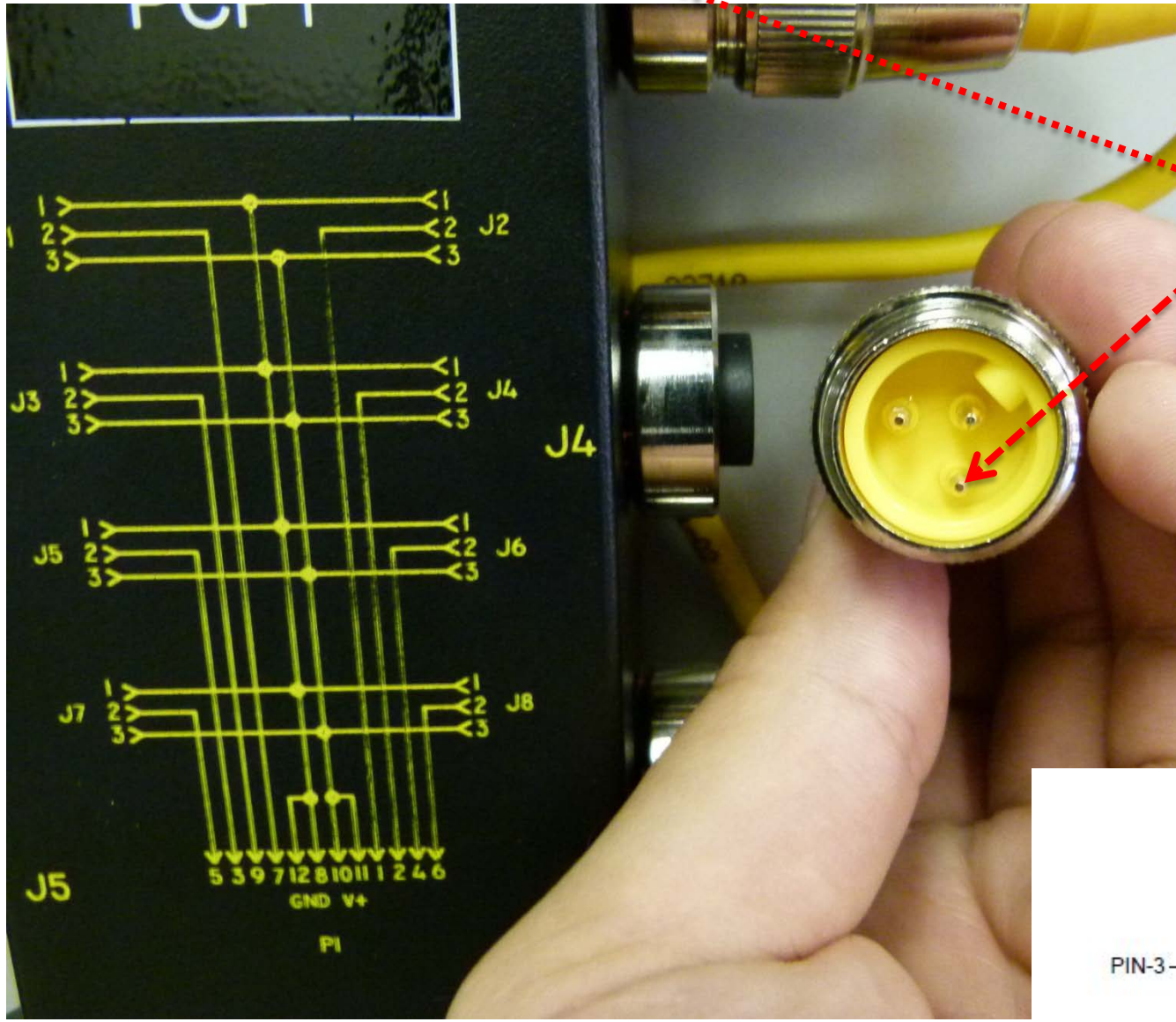
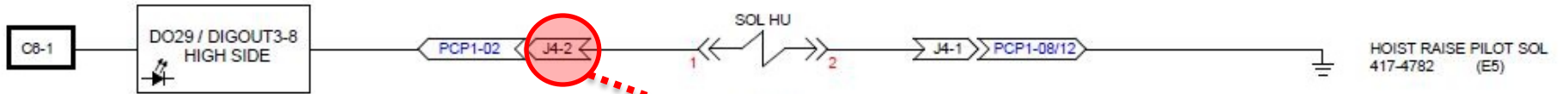

PCP1 J4-2

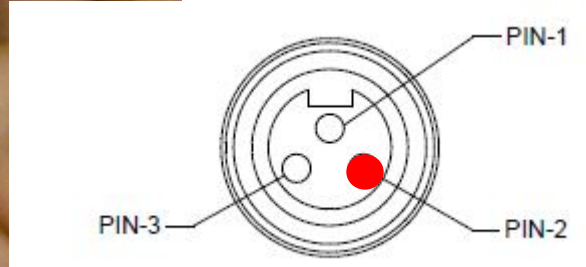

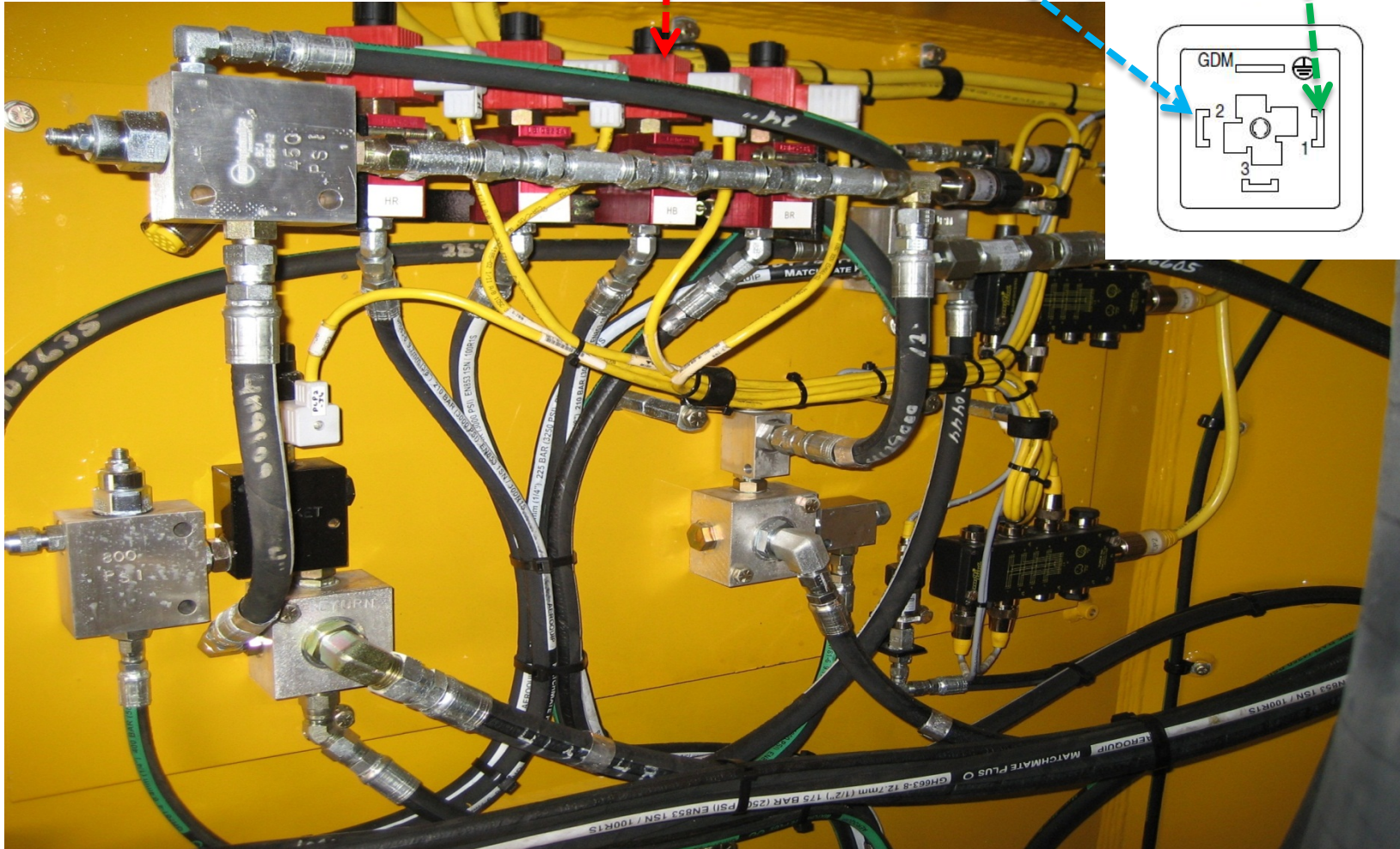
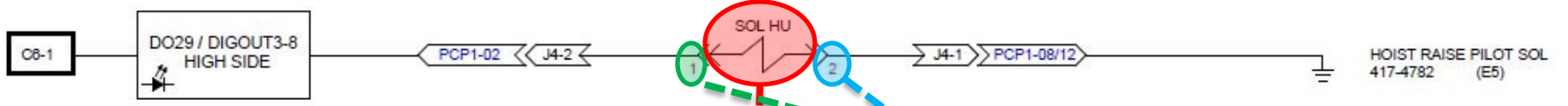

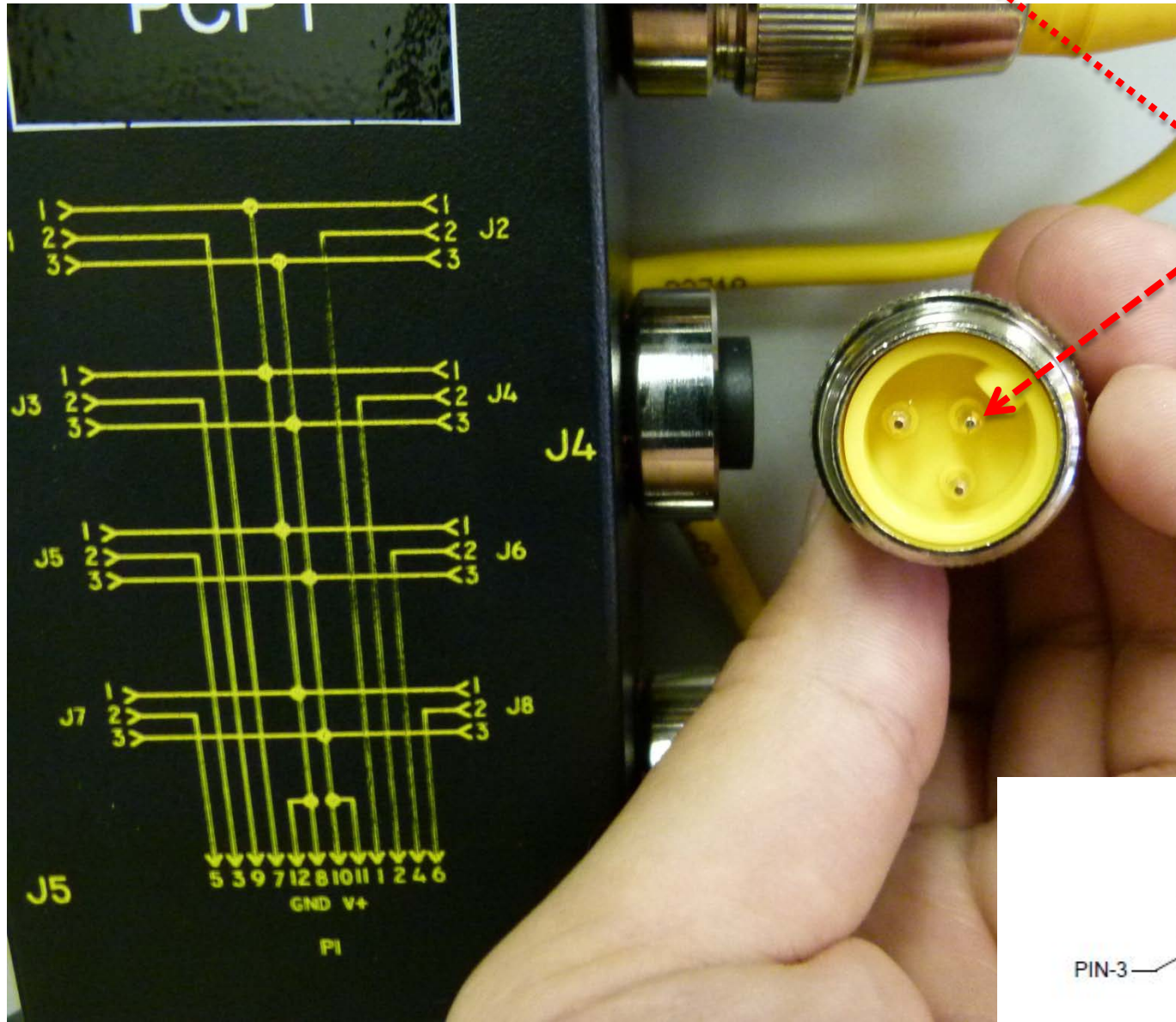
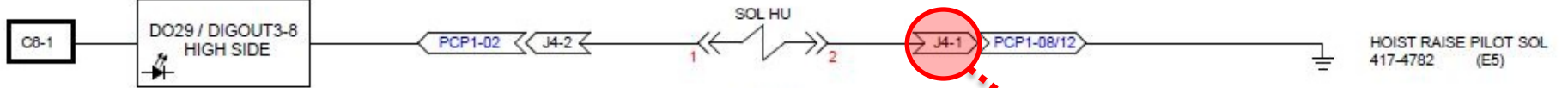

PCP1 J4-1

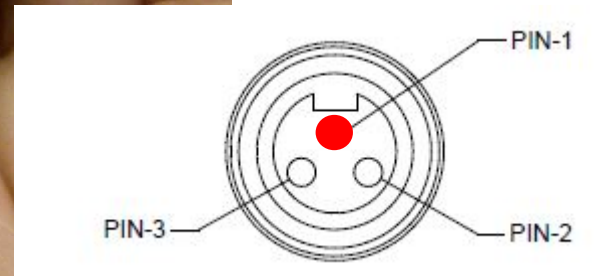

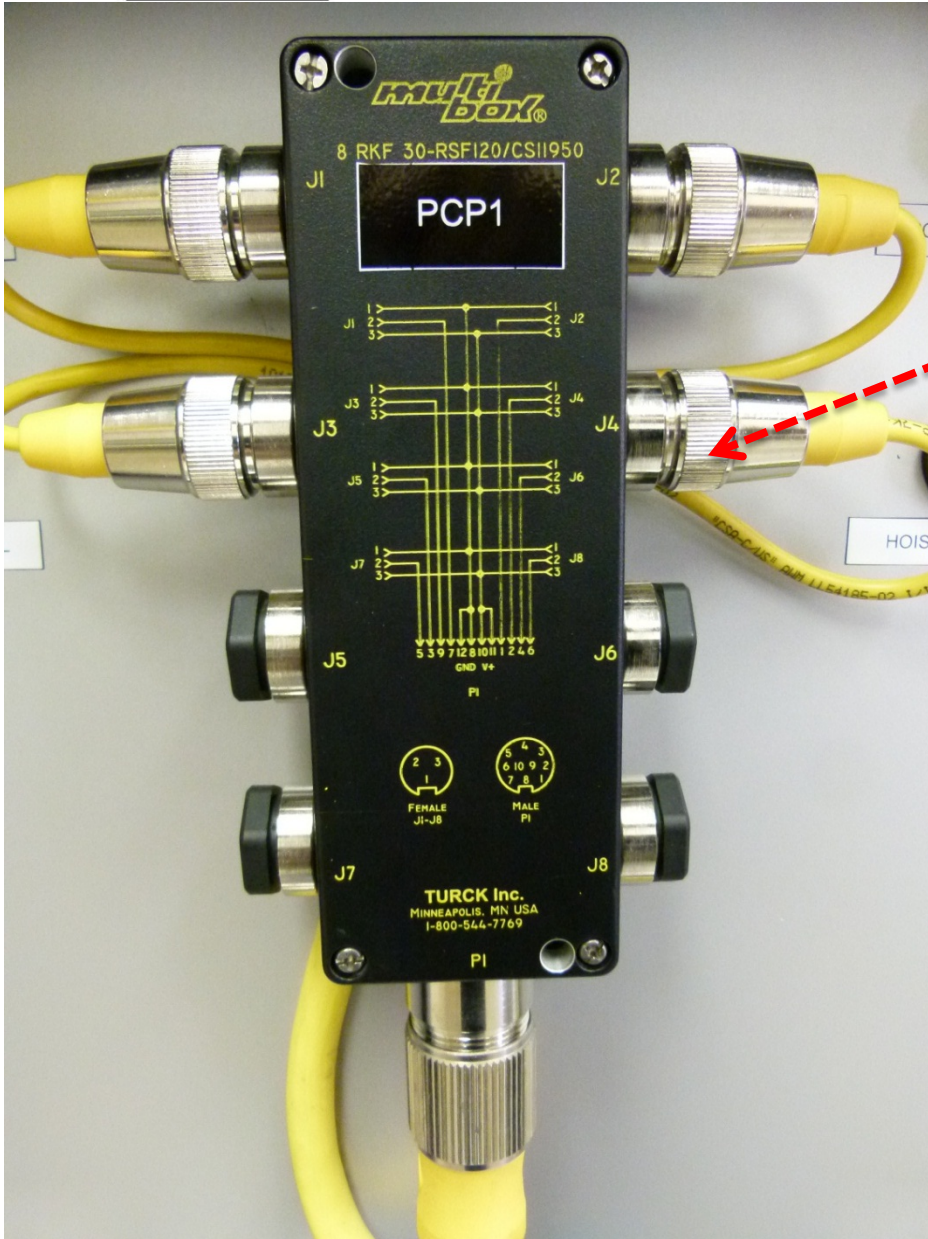
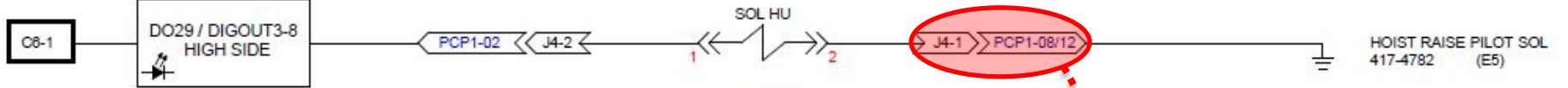

Break out Box PCP1  
Connector J4  
Pin 08 and 12

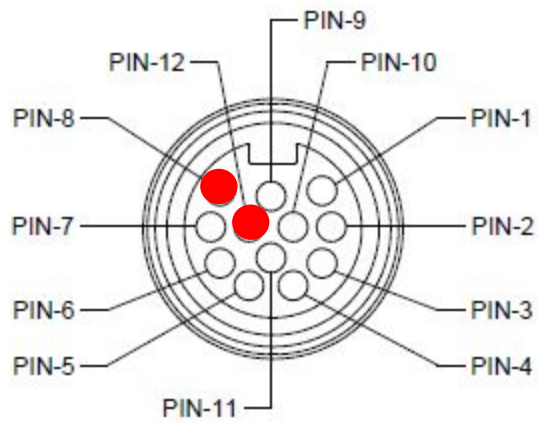

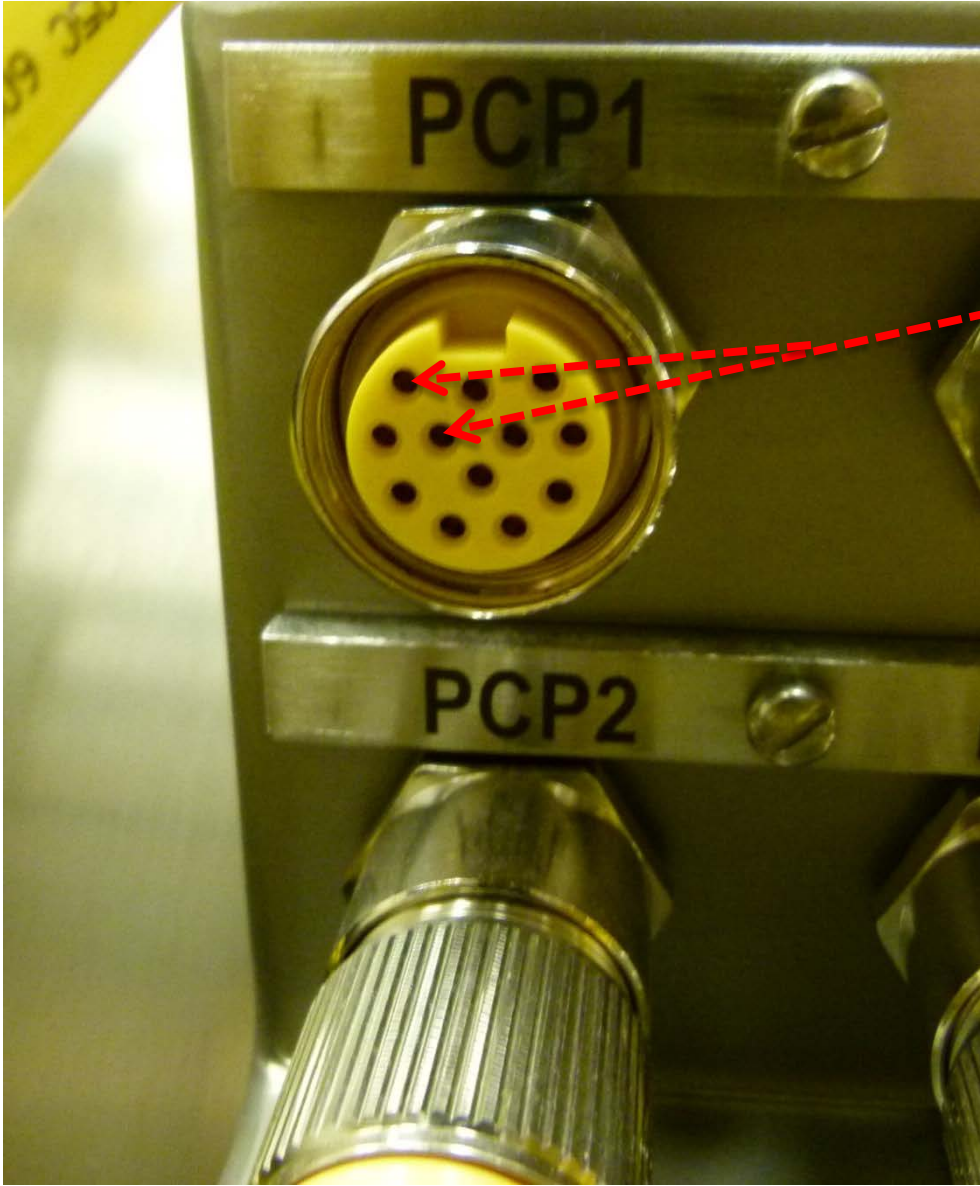
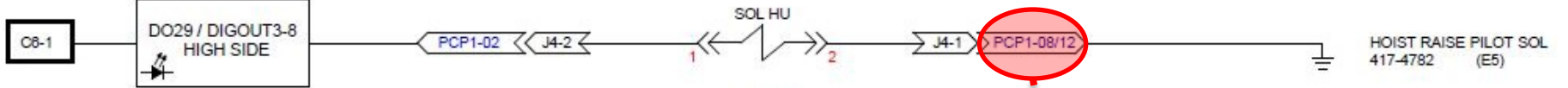

PCP1-08/12

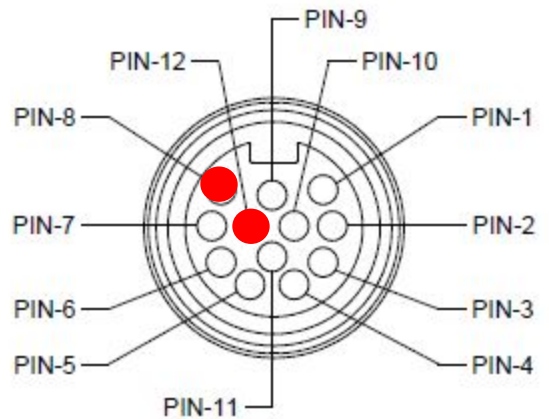

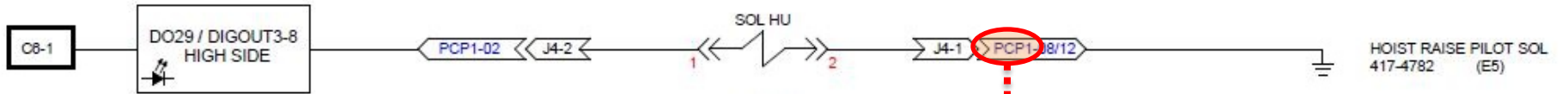

PCP1 12 pin cable at the back of the LVCC

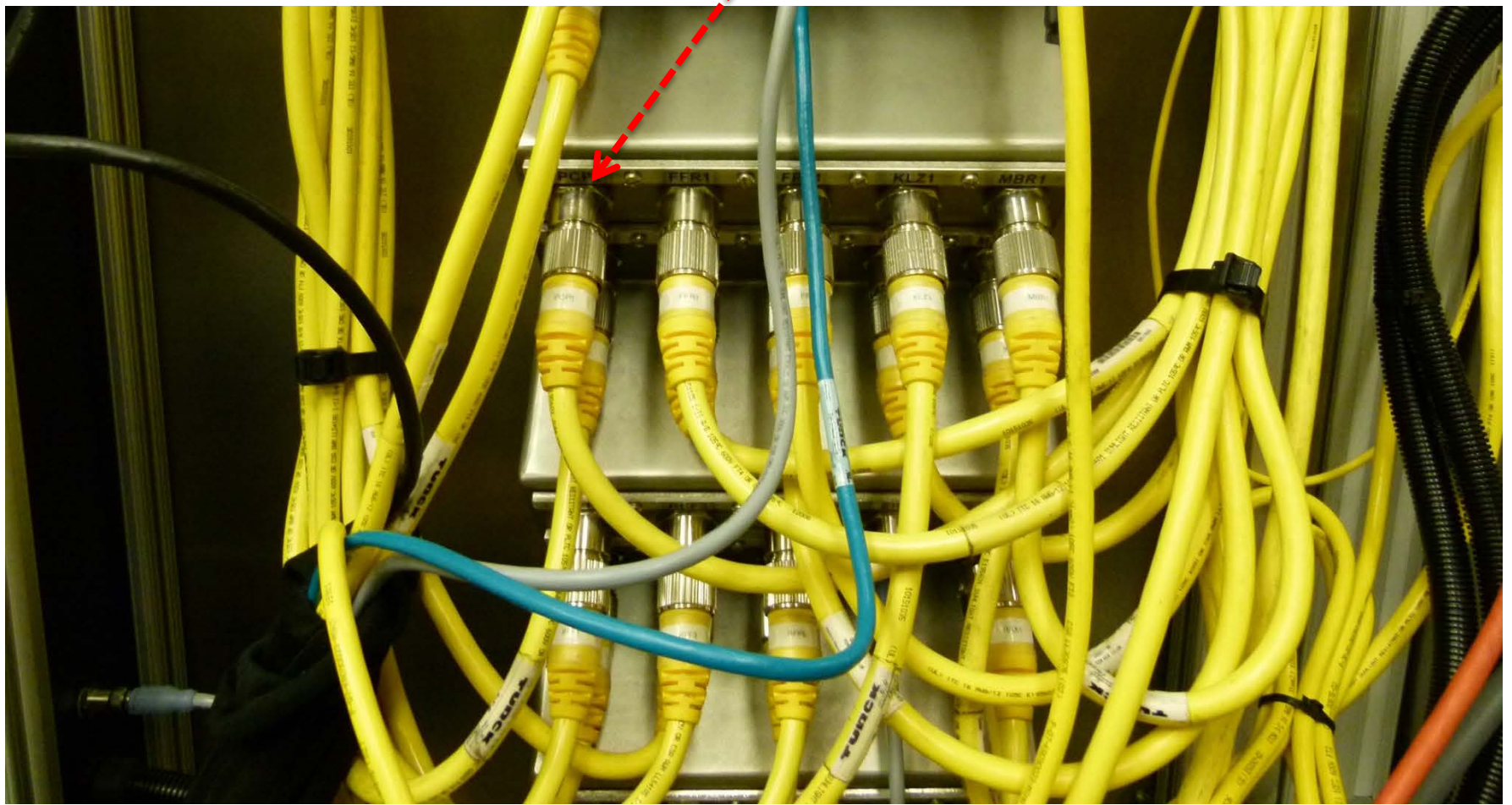

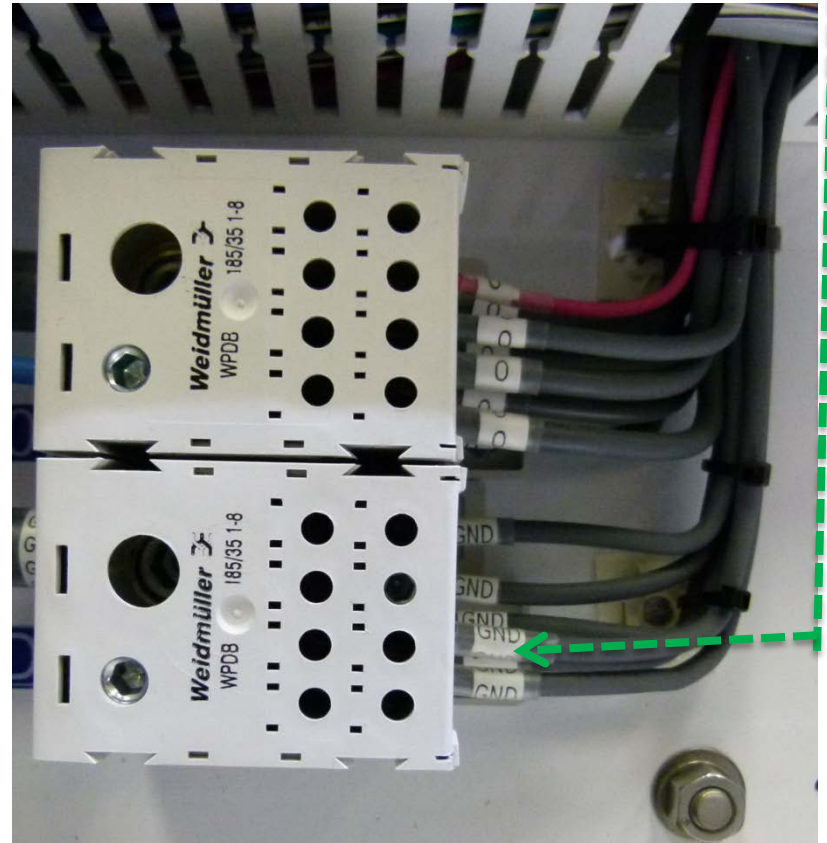
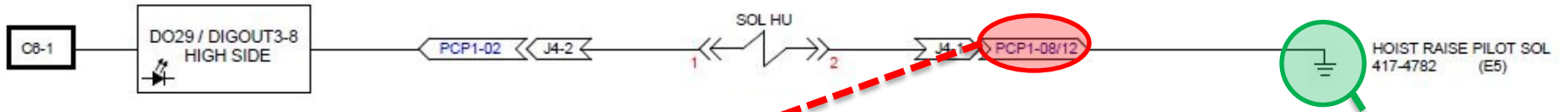

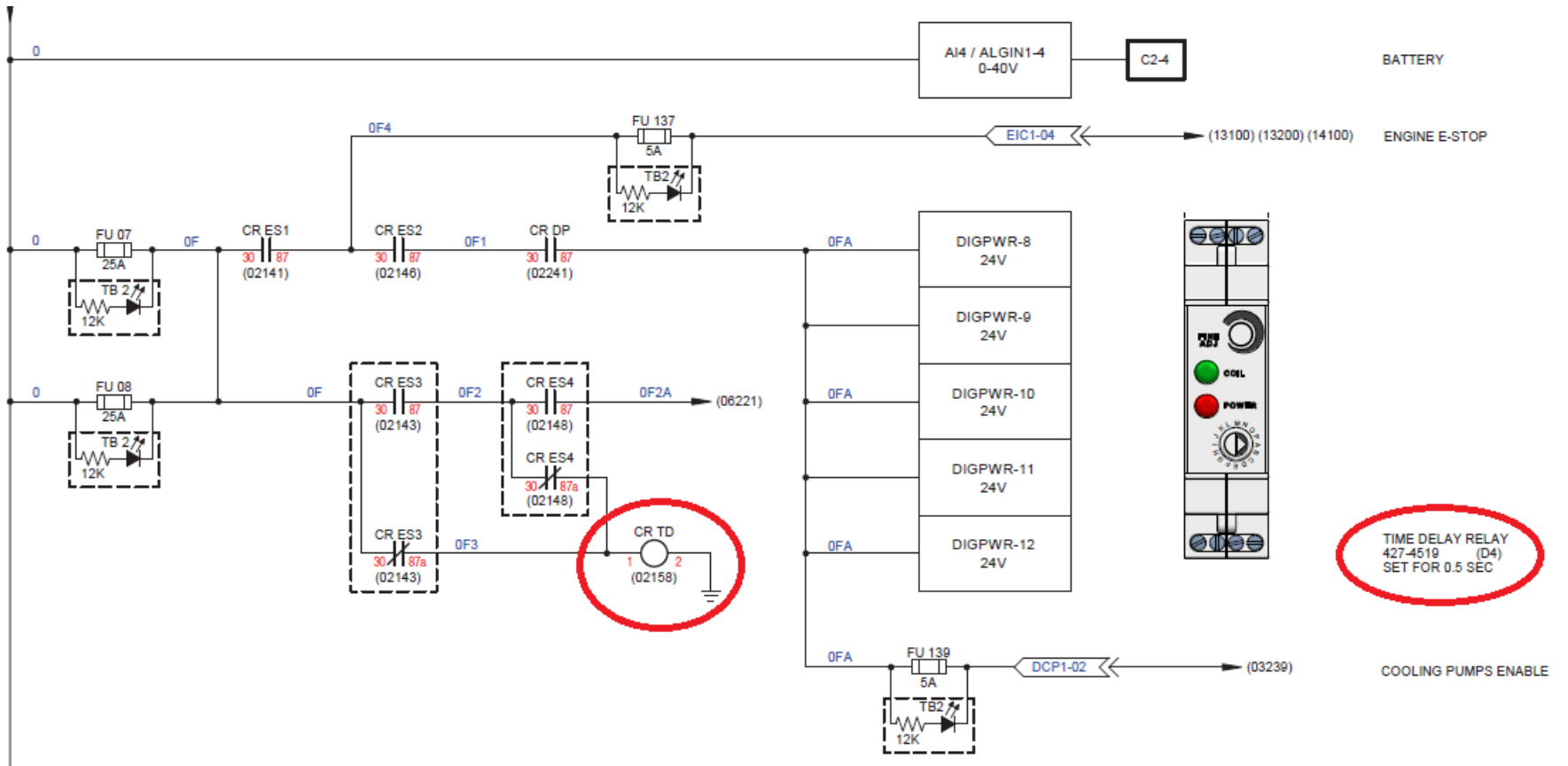

# Old Emergency Stop Schematics



# New Emergency Stop Schematics

